

PREPARE THE GROUND, UNWRAP THE PACKAGE,
LAY OUT THE COMPONENTS, FIND THE TOOLS.

OSTO DRESDEN 34

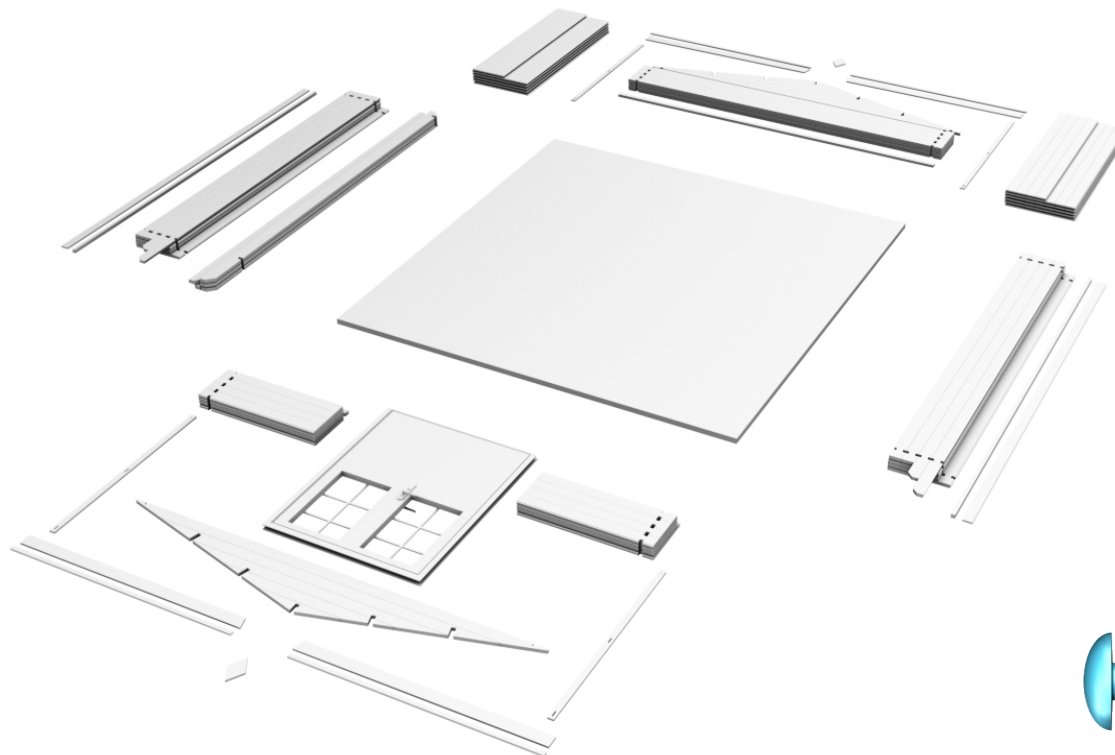
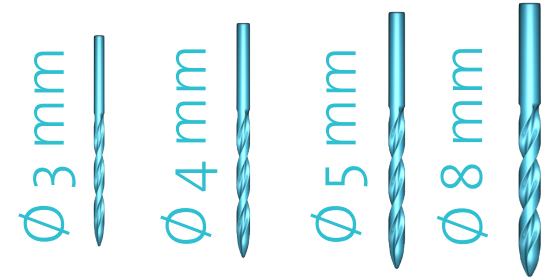
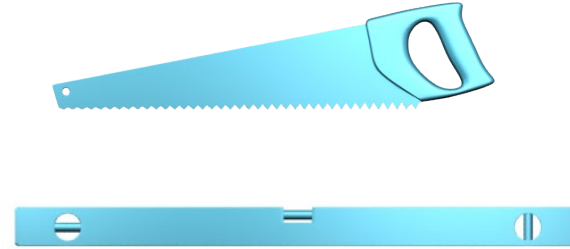
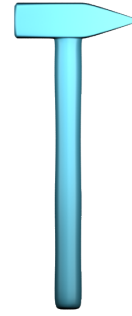
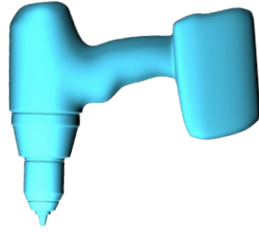
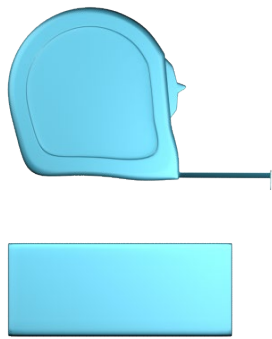

4x40 × 100

4x50 × 350

5x70 × 10

6x140 × 25

M8x70 × 12

LAY OUT THE **BOTTOM** LOGS
AND **SQUARE** IT BY MEASURING
FROM CORNER TO **CORNER**.



OSTO DRESDEN 34

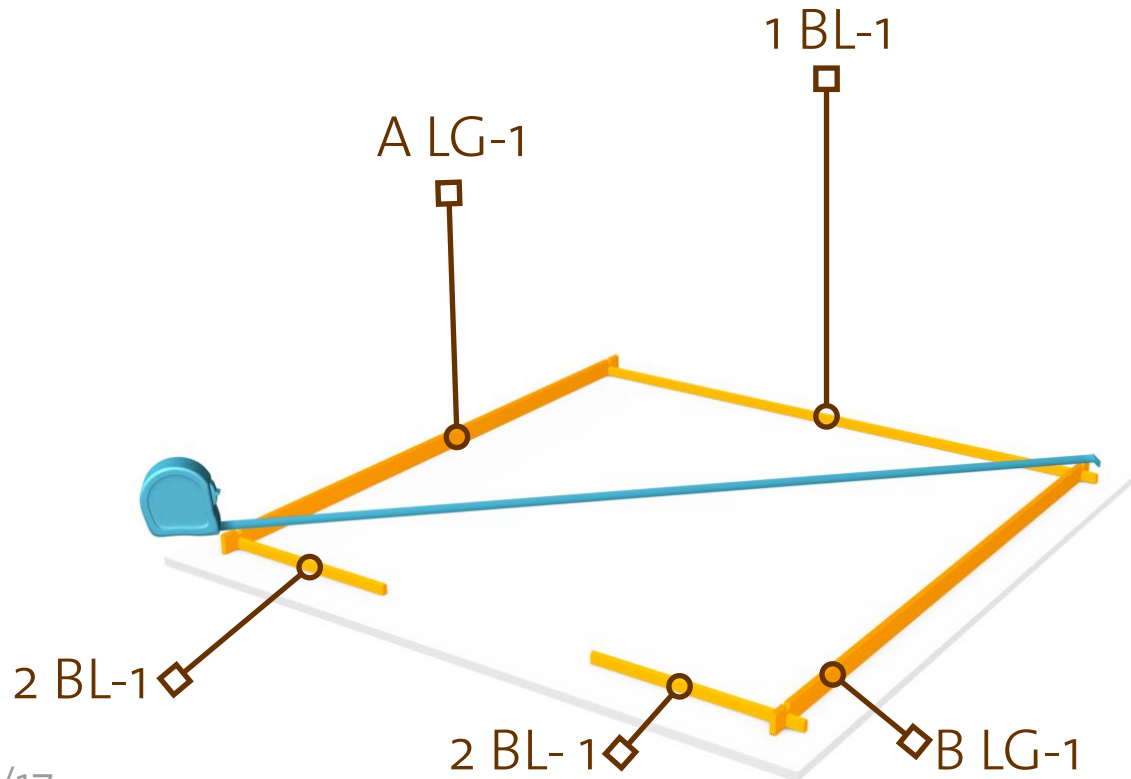
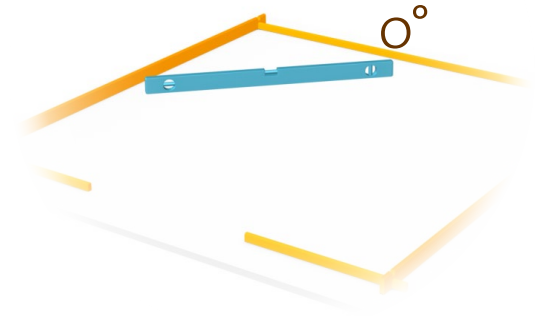
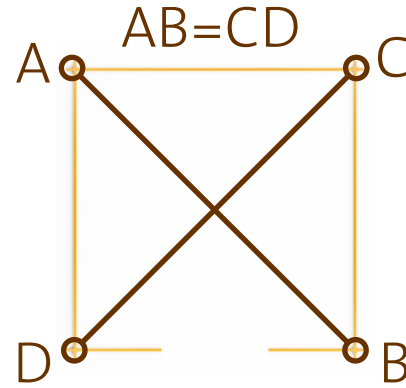

MAKE **SURE** THAT THE BOTTOM LOGS
ARE INSTALLED ON A **LEVEL** SURFACE.
CHECKING ALL DIRECTIONS,
INCLUDING **CORNER** TO CORNER. **2%**

ATTACH THE LOGS
WITH SCREWS.

5x70 × 4
Ø 4 mm

OSTO DRESDEN 34

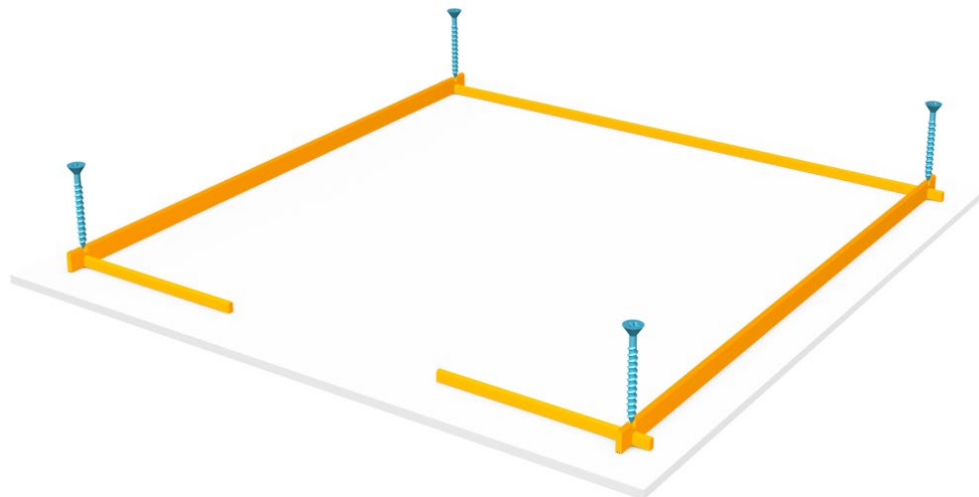
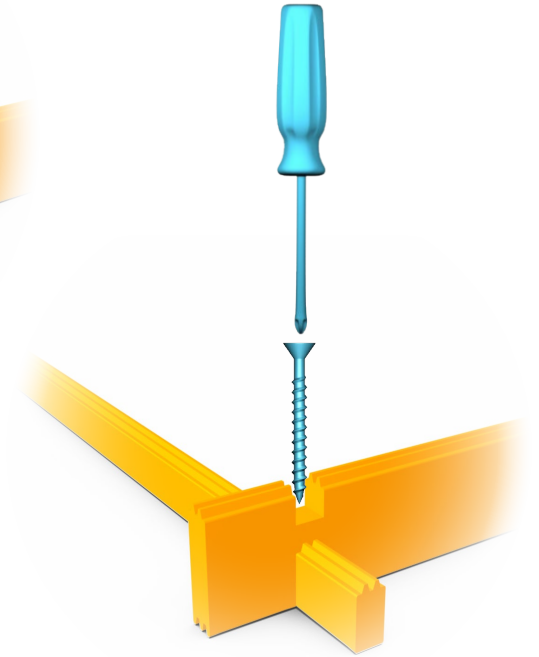
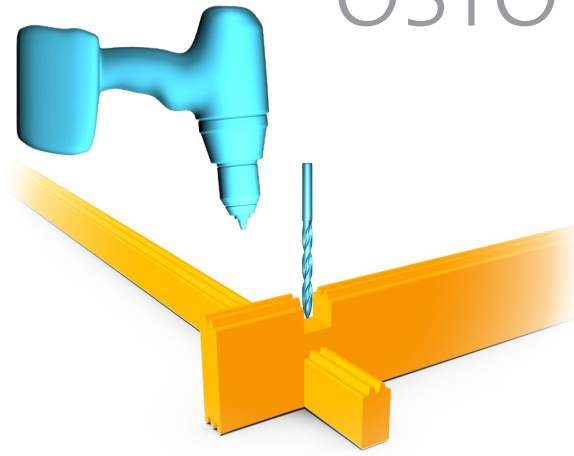

ATTACH THE FIRST ROW OF
WALL LOGS INTO THE BOTTOM
LOGS WITH **SCREWS**.

OSTO DRESDEN 34

- 5x70 × 4
- 6x140 × 5
- Ø 4 mm
- Ø 5 mm

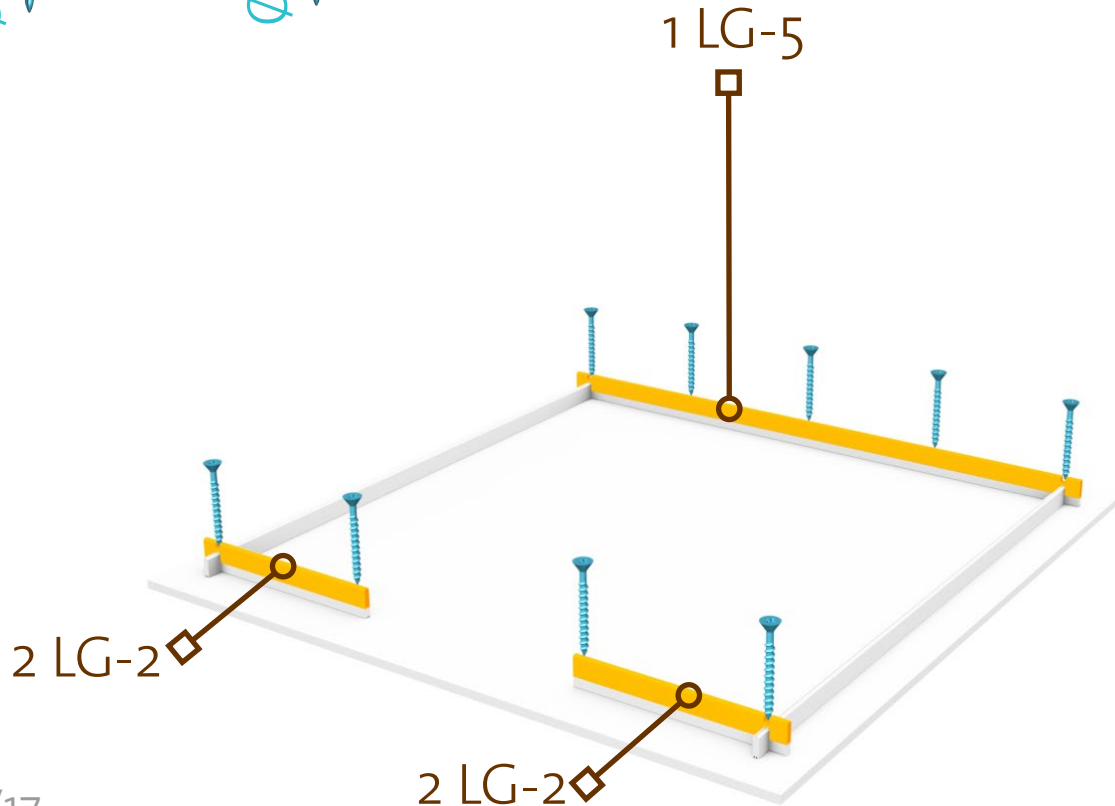
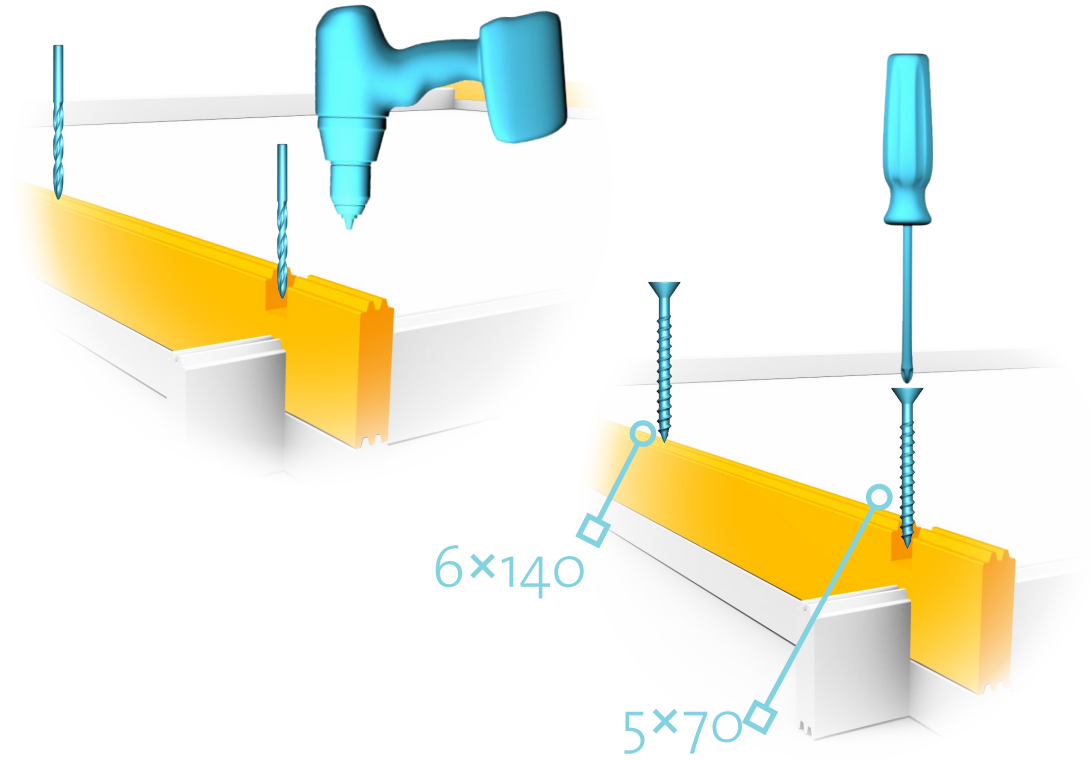

AFTER PLACING 3-4 ROWS OF WALL LOGS, TAP EACH WALL LOG IN PLACE USING A HAMMER AND THE HITBLOCK PROVIDED, TO TIGHTEN THE LOGS.

OSTO DRESDEN 34

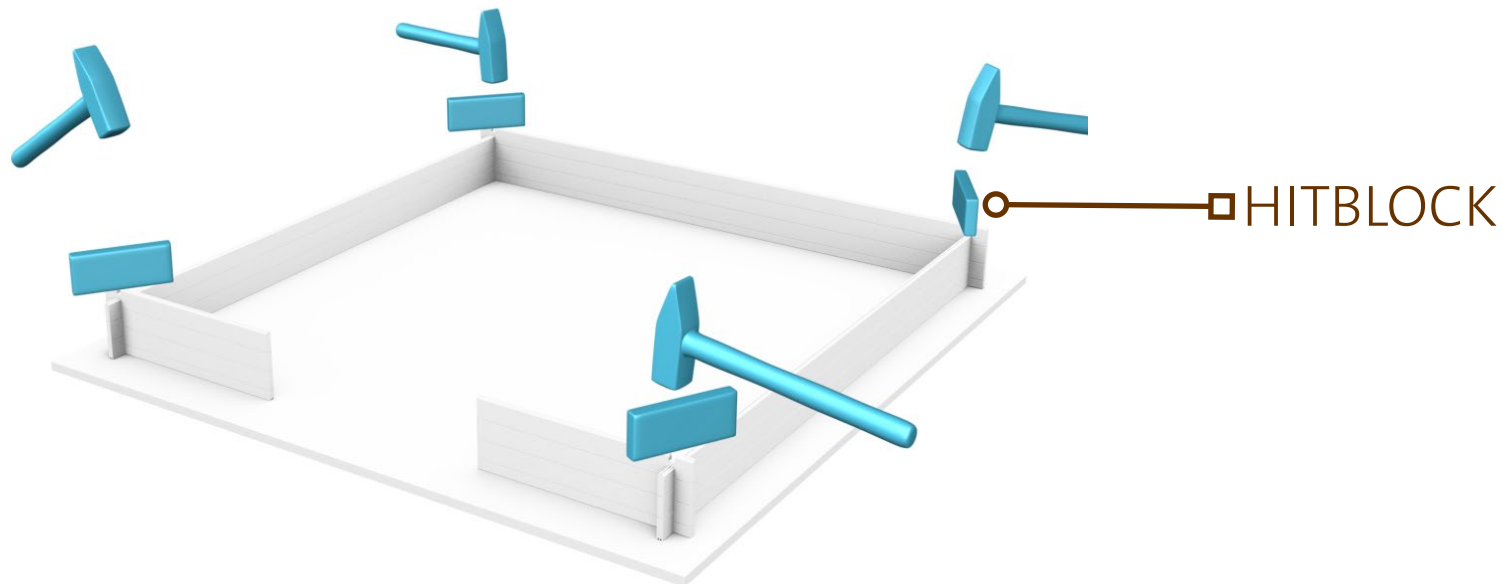

SLIDE THE DOOR IN,
ATTACH THE HANDLE.

OSTO DRESDEN 34

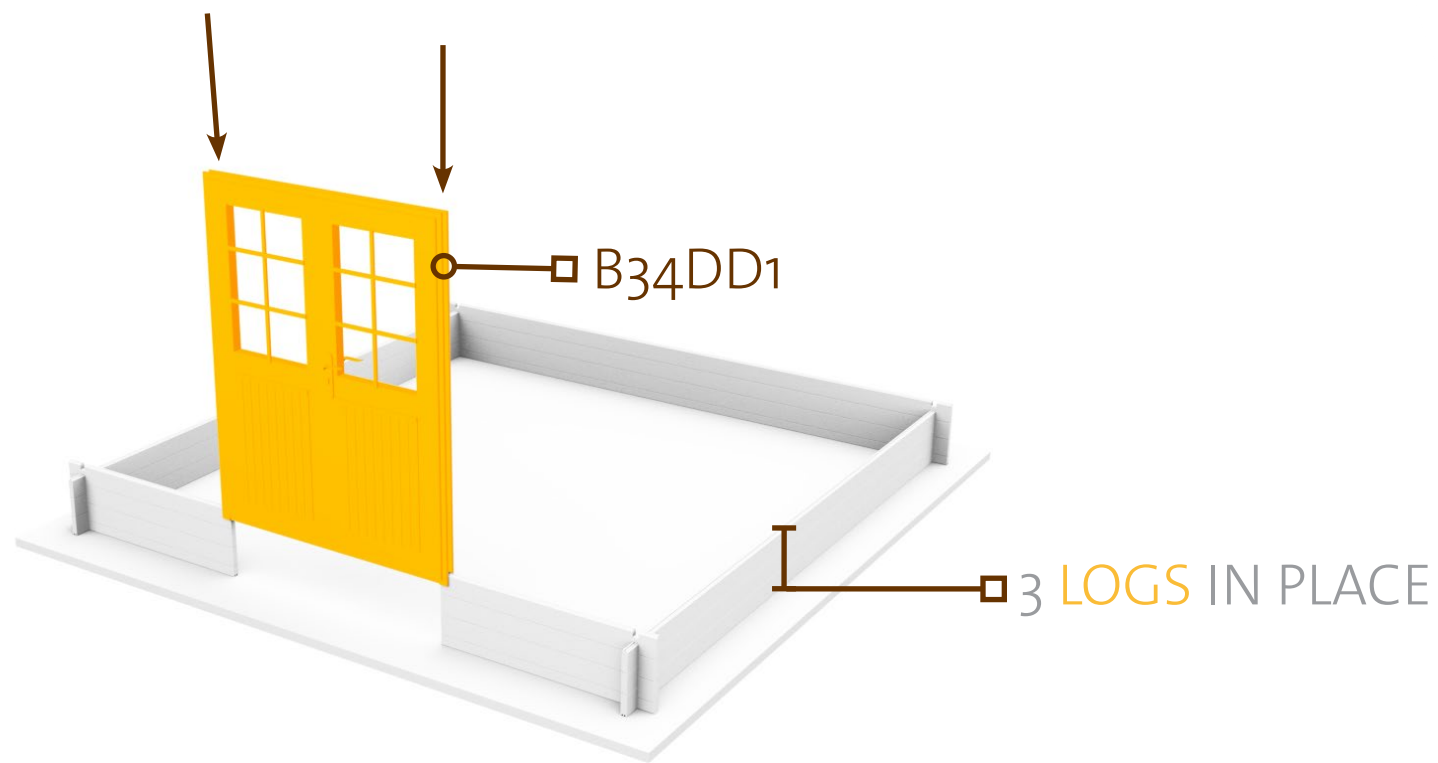
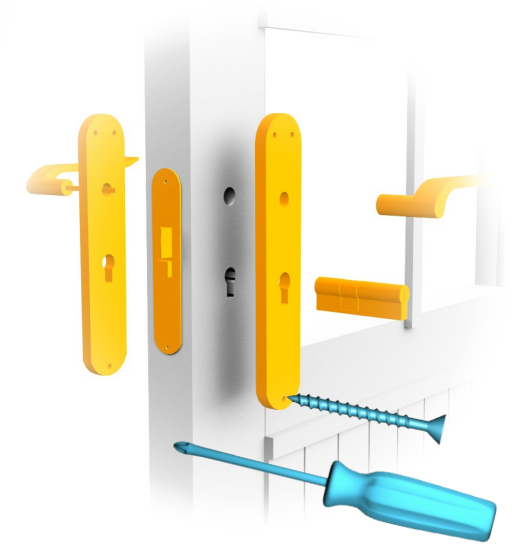

DON`T FORGET TO
TIGHTEN THE LOGS AFTER
EVERY 3-4 ROWS.

OSTO DRESDEN 34

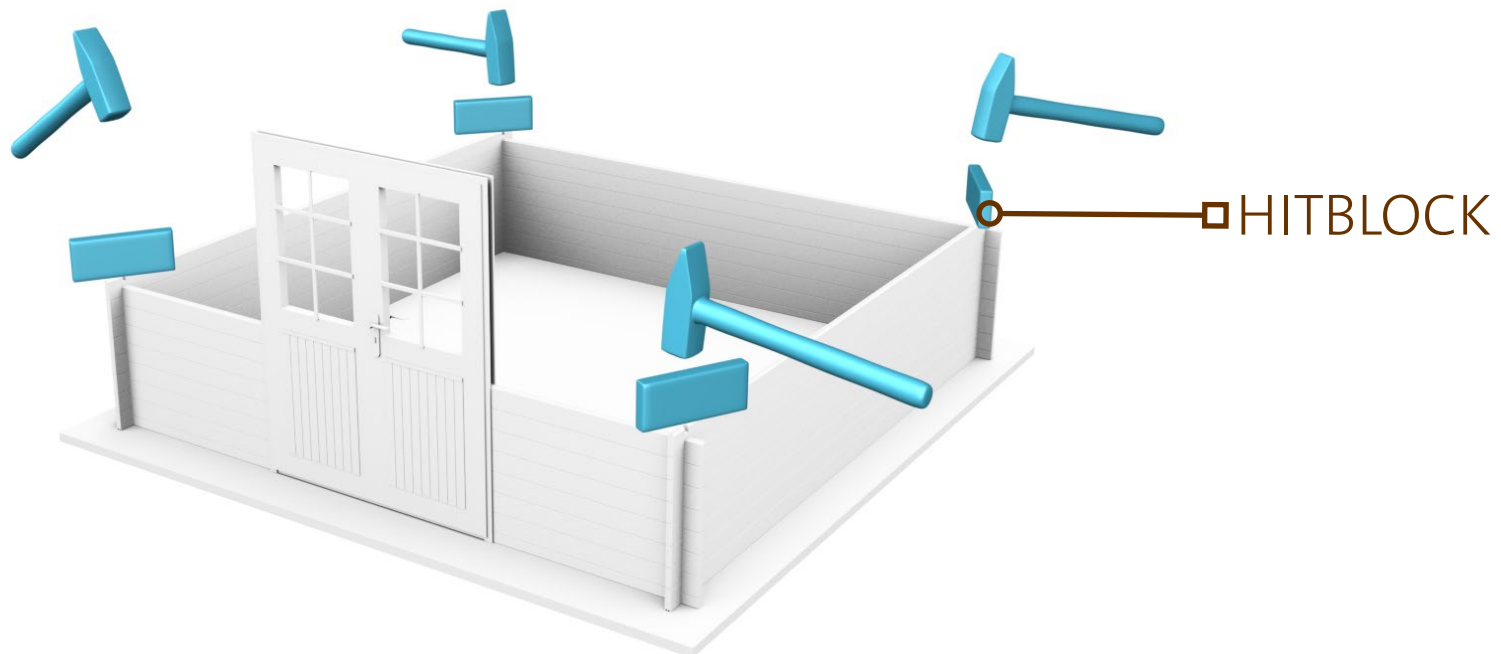

INSTALL THE GABLES WITH LONG SCREWS TO THE WALL LOGS ON THE FRONT AND REAR WALLS.

OSTO DRESDEN 34

6x140 × 4
Ø 5 mm

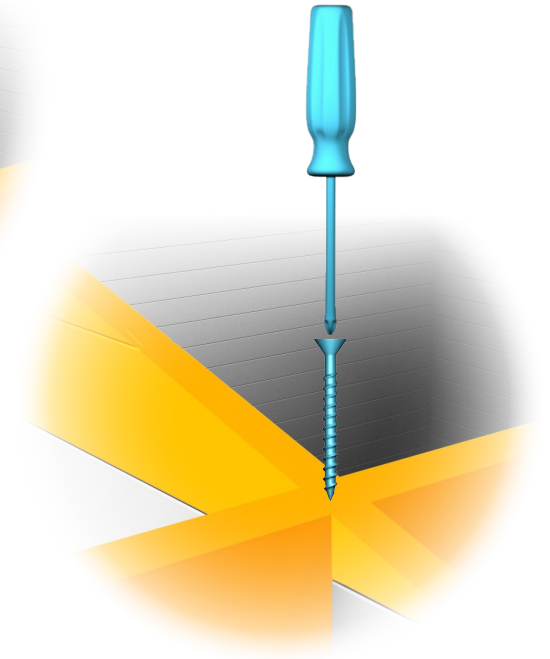
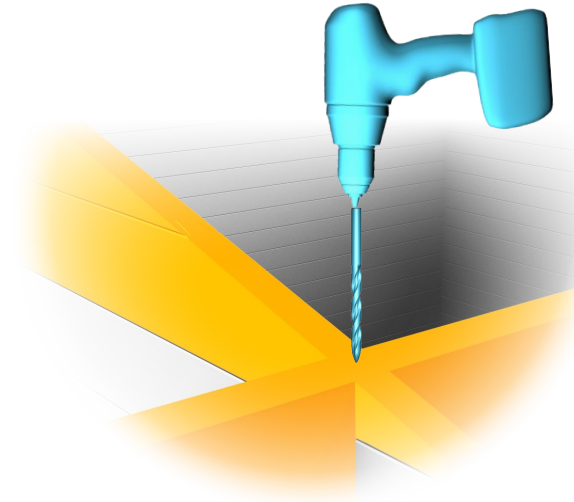
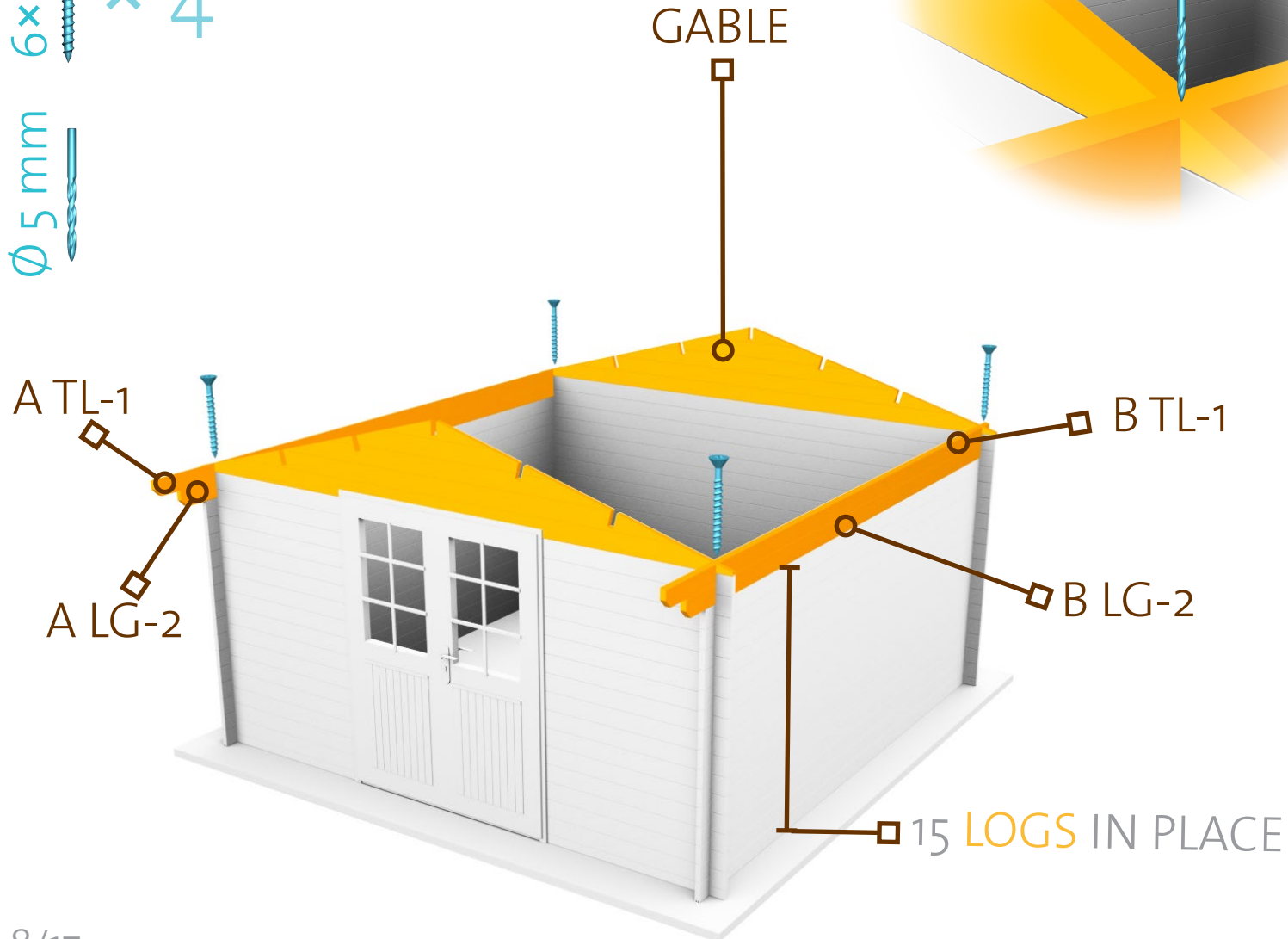

INSTALL THE ROOF PURLINS AND ATTACH THEM WITH SCREWS.

OSTO DRESDEN 34

6x140 × 10
Ø 5 mm

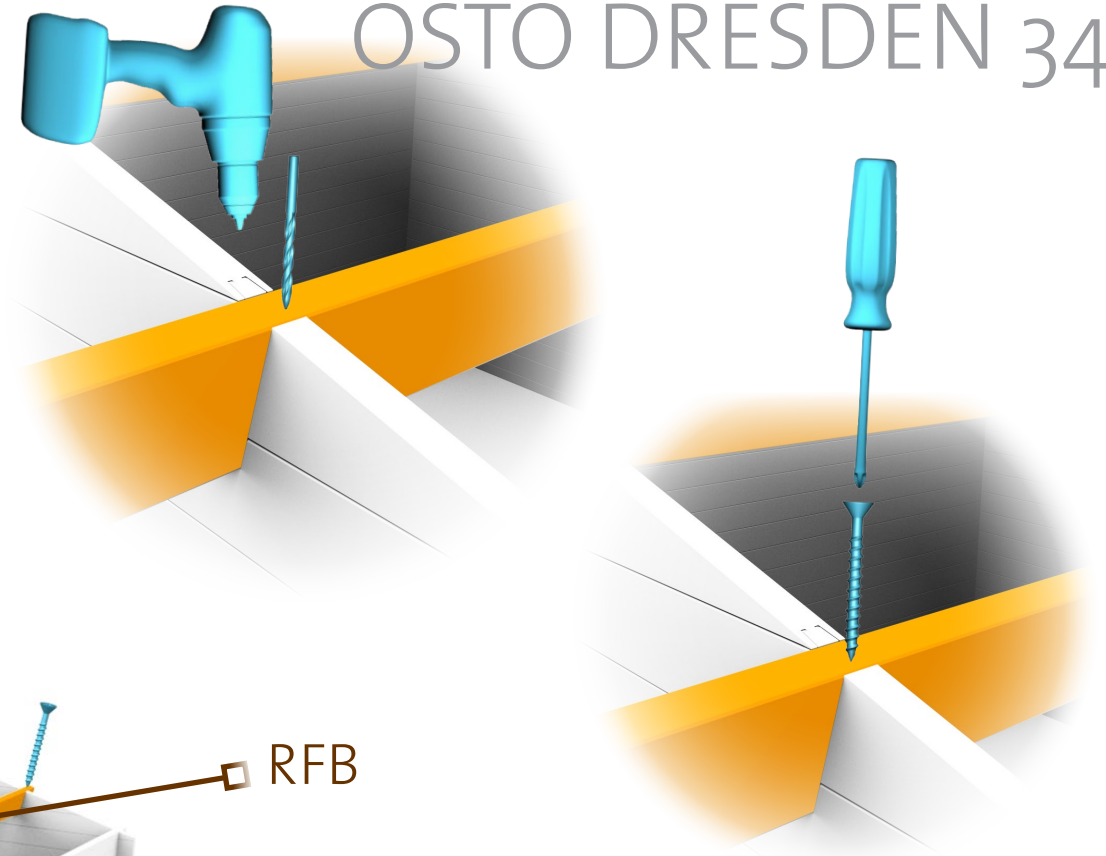
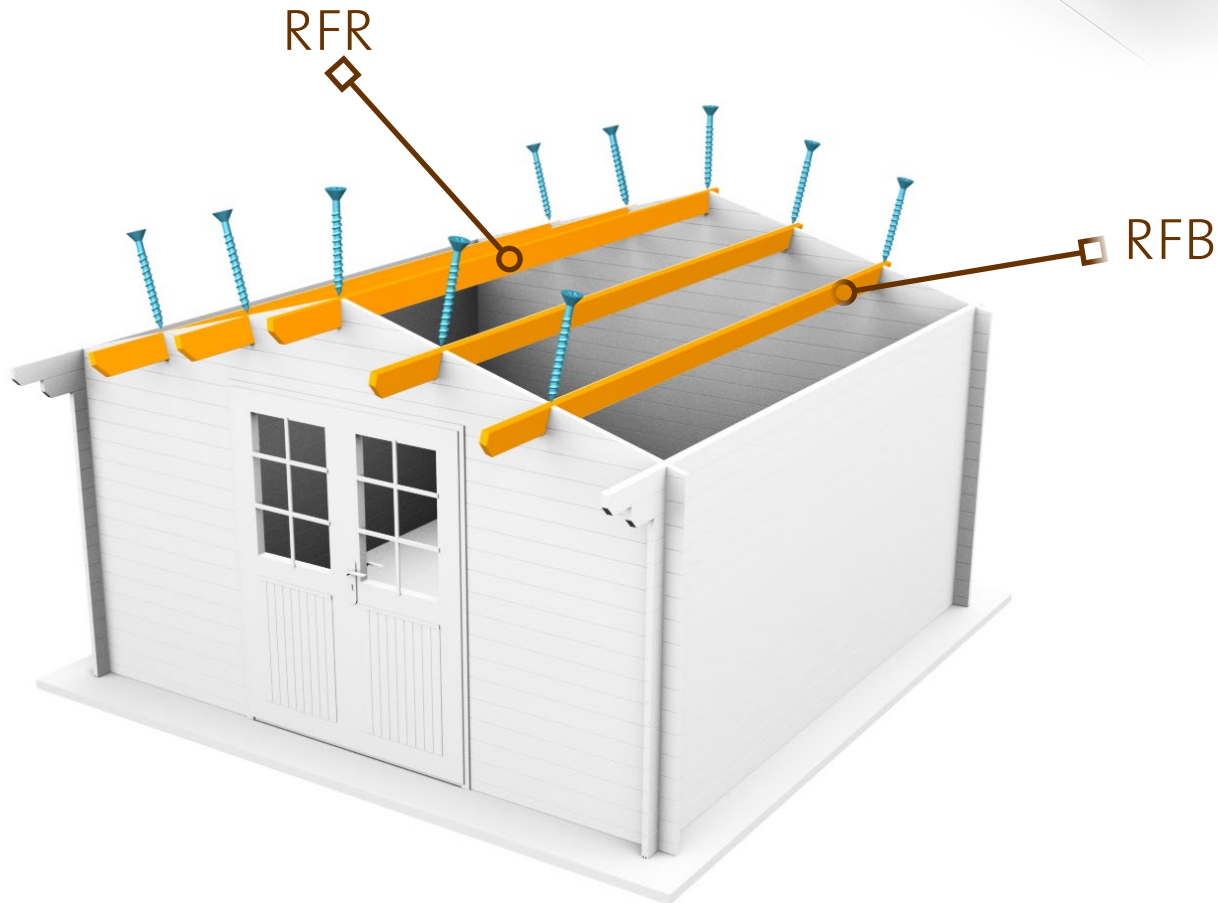

PLACE THE FIRST **ROOFBOARD** FLUSH WITH THE **END** OF THE PURLINS AND ATTACH WITH 8 SCREWS, 4 **INTO** EACH NEXT.

4x50  × 336

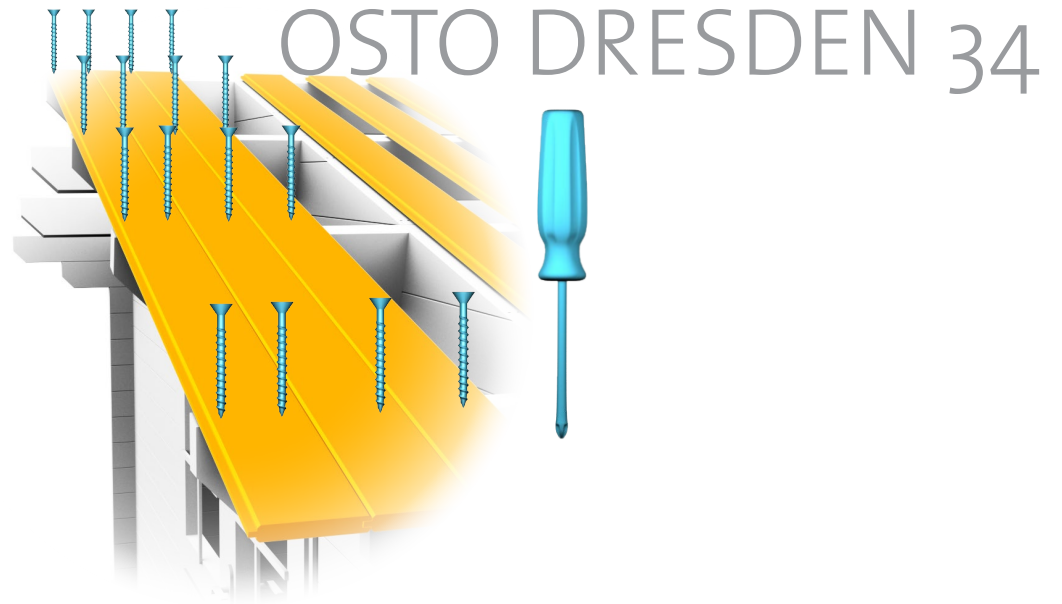

FOR THE FASCIA TRIMS
INSERT **SCREWS** AFTER
EVERY 0,5 METERS.

OSTO DRESDEN 34

4x40
× 40

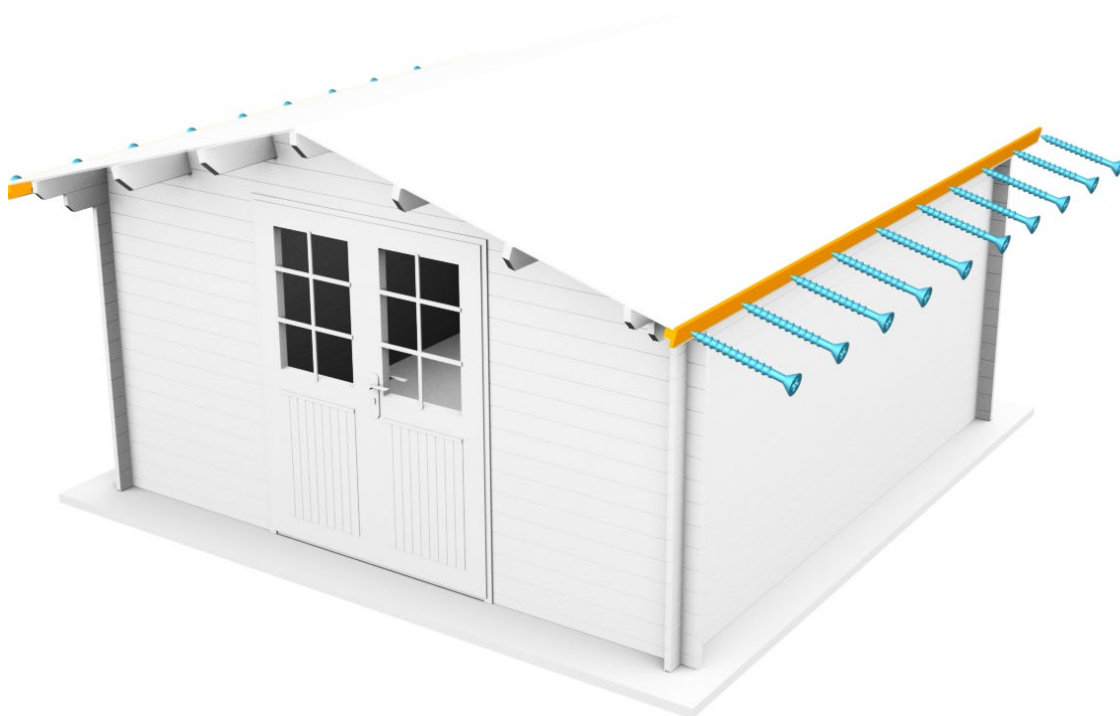
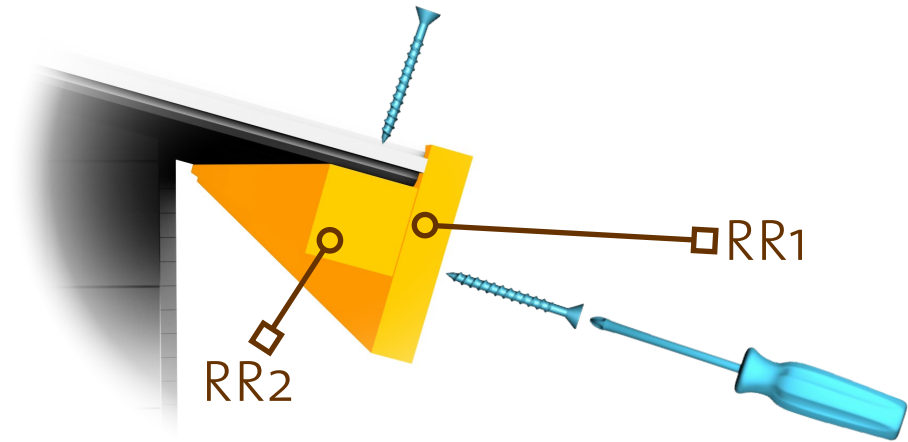

EAVES EDGES GO ON TOP OF THE ROOFING*.

*(NOT INCLUDED)

4x40 × 40

Ø 3 mm

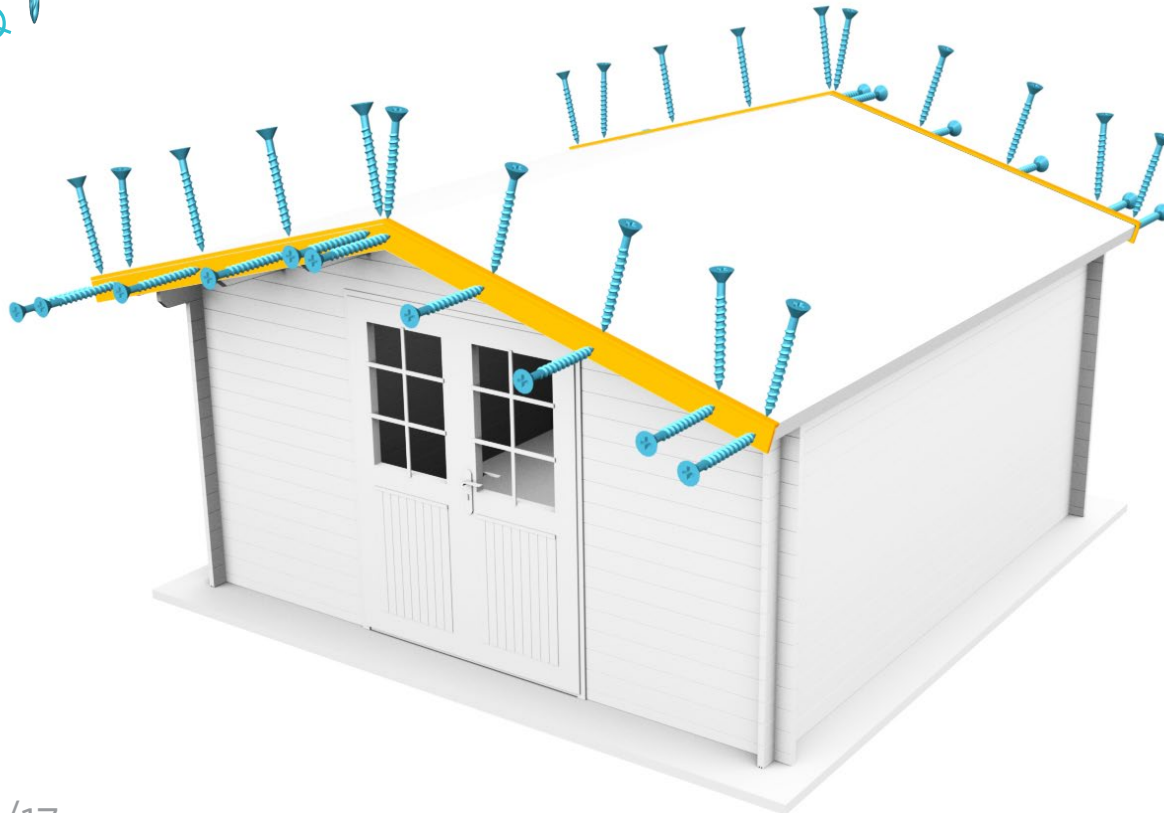
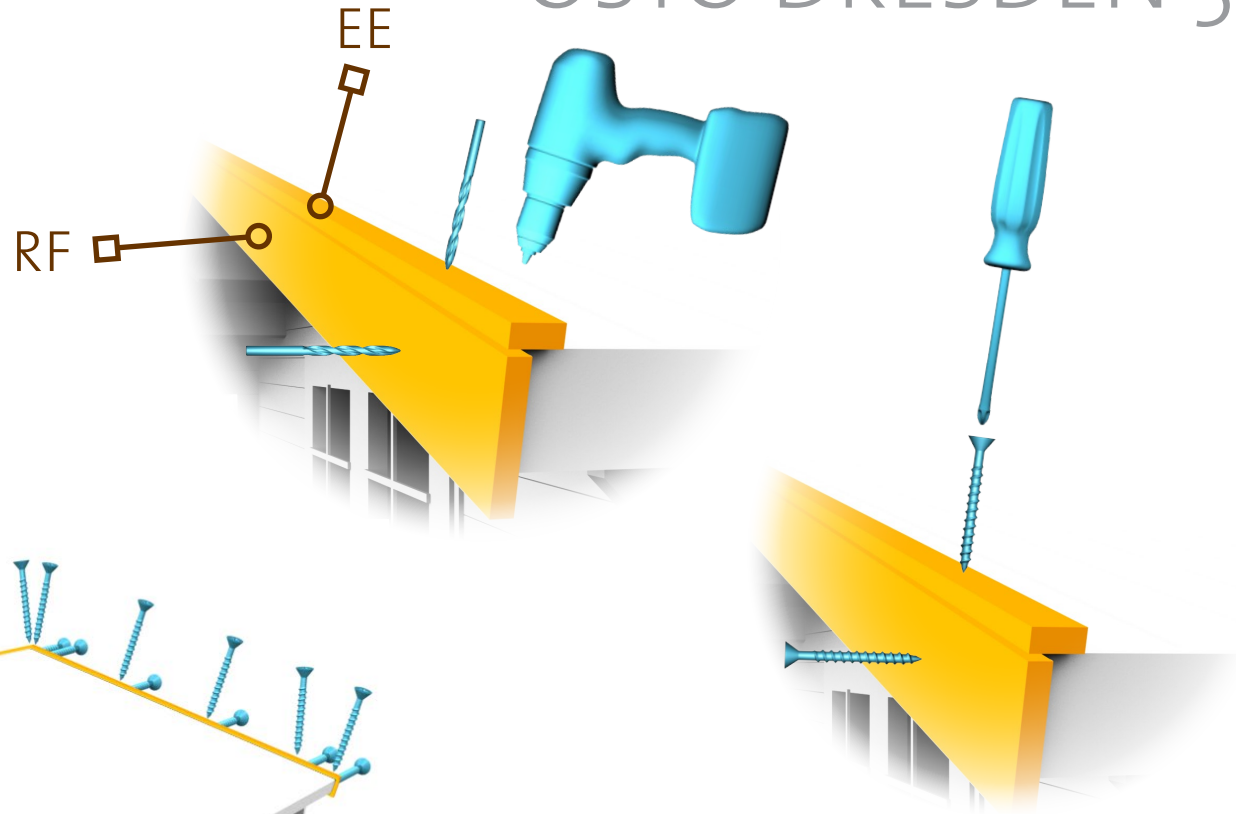

ATTACH ROMB WITH SCREWS.

OSTO DRESDEN 34

4x40
× 4
Ø 3 mm

ROMB

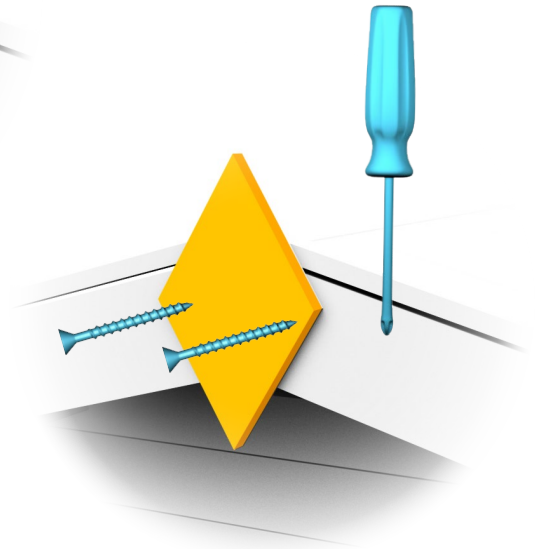
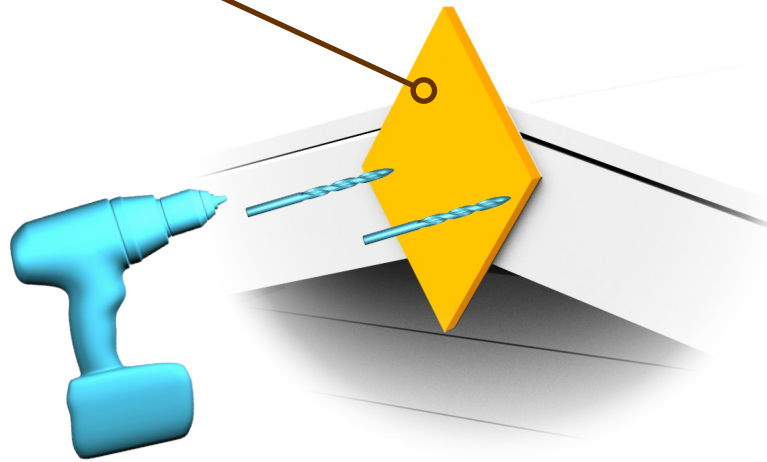

DRILL THROUGH THE WALL, HOLE MUST BE AT THE BOTTOM OF THE OVAL, ATTACH WITH BOLT.

M8x70 × 12

Ø 8 mm

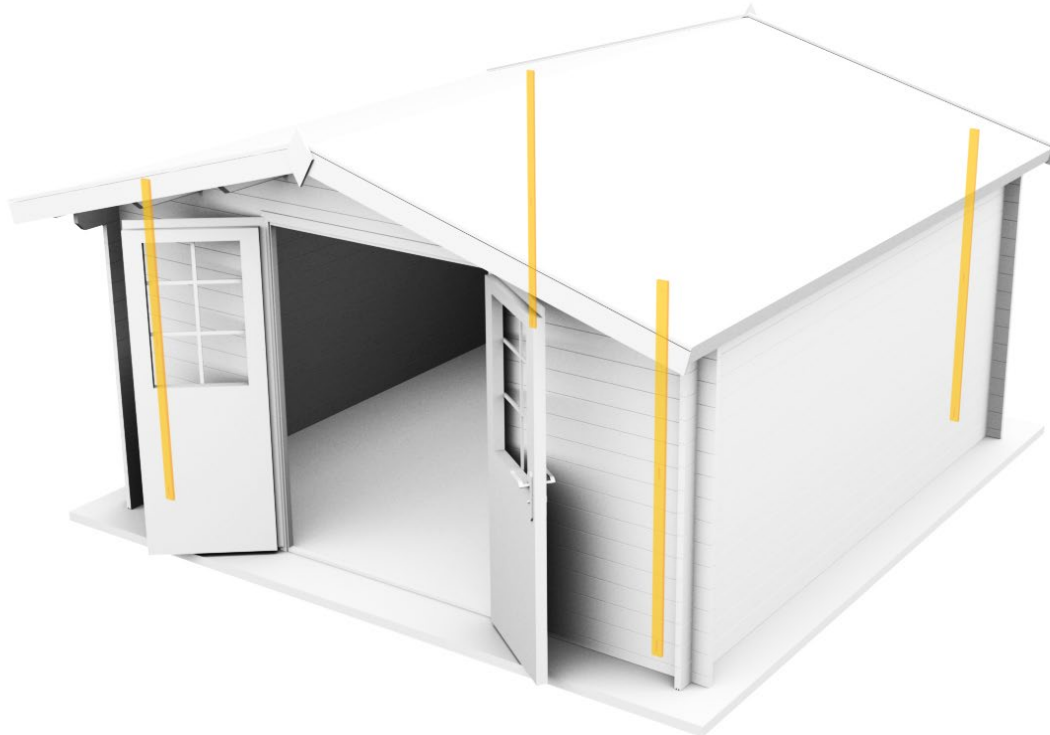
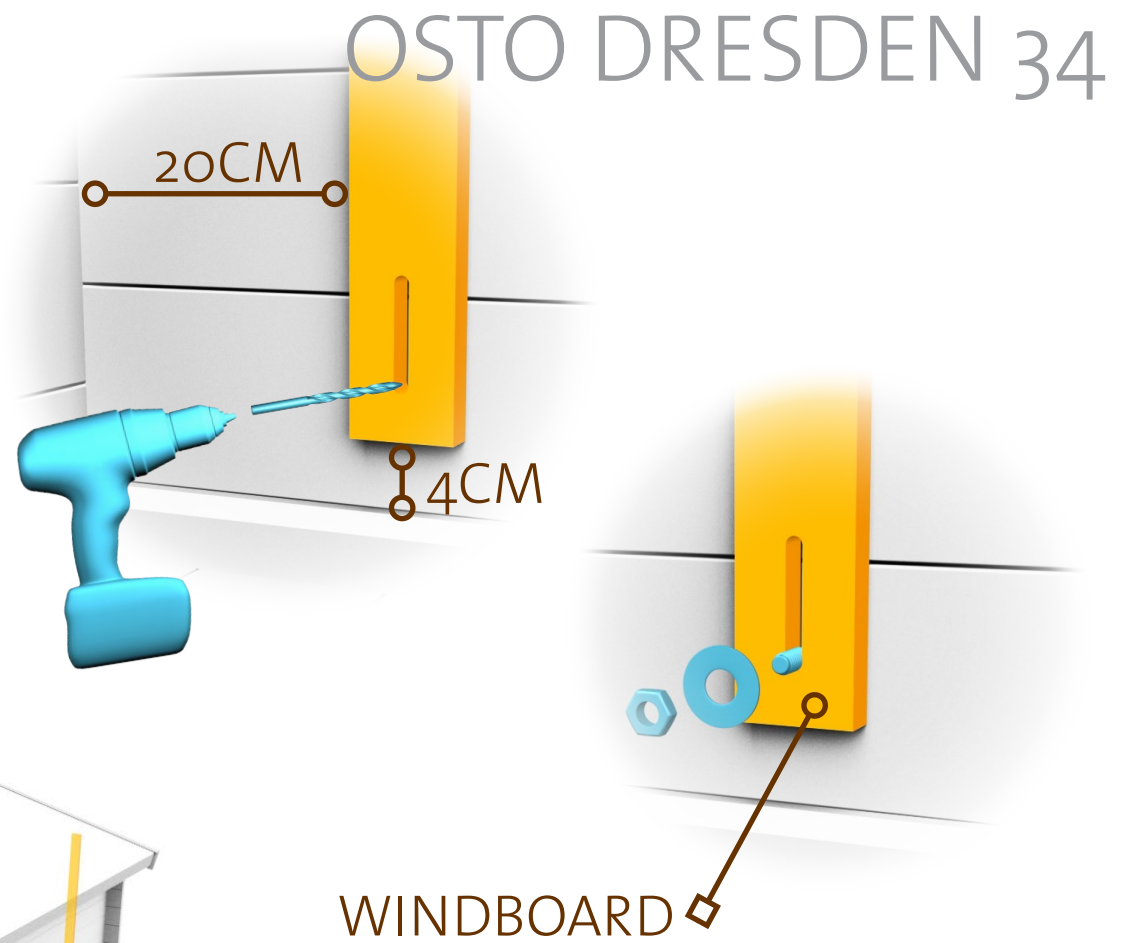

IF DOOR IS TILTED,
PUSH THE DOOR FRAME SO
THAT ALL CORNERS ARE 90° .

OSTO DRESDEN 34

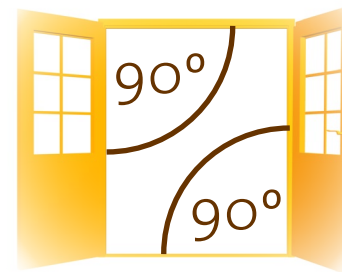
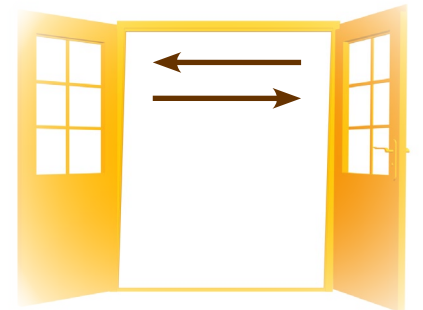

IF **DOORS** ARE IN DIFFERENT HEIGHTS
OR THERE IS A GAP **BETWEEN** THEM,
ADJUST 3 SCREWS ON DOOR HINGES.

OSTO DRESDEN 34

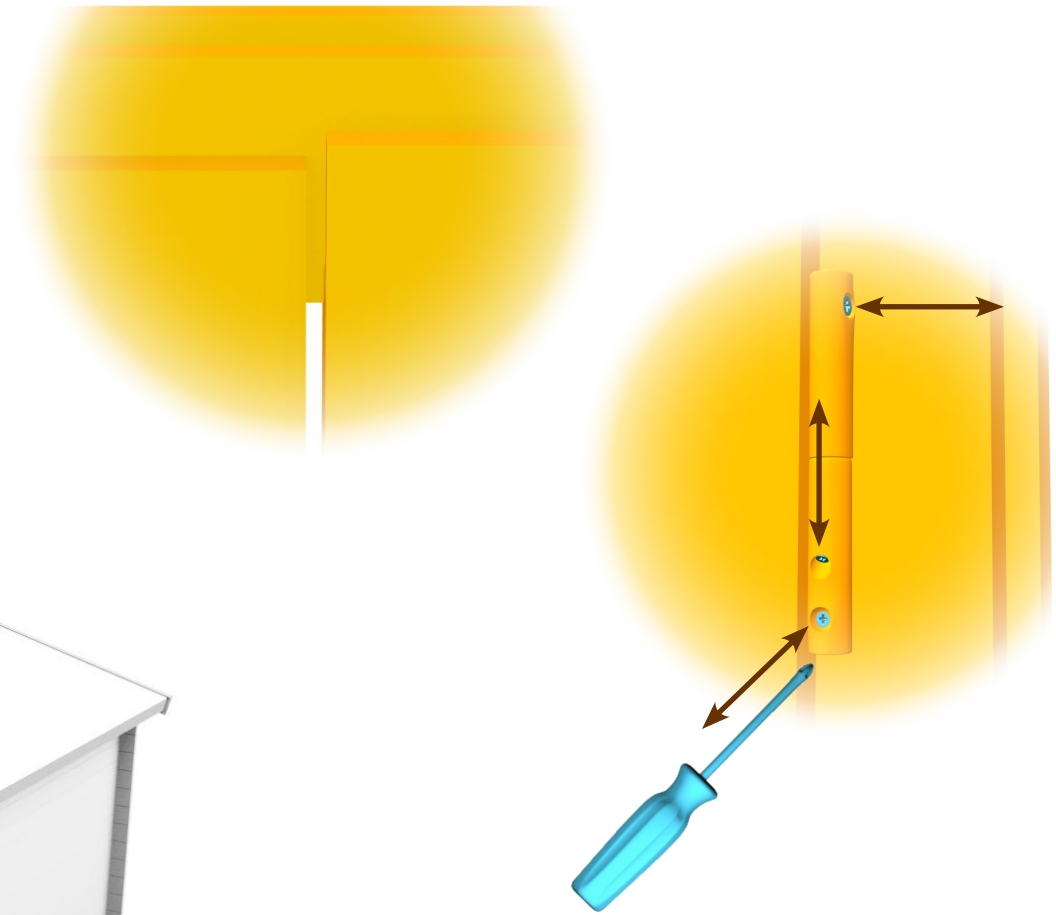

WHEN THE **HOUSE** IS ASSEMBLED, YOU SHOULD **COVER** THE TIMBER WITH **WOOD** PROTECTIVE SEAL, PAINT OR **STAIN** AS SOON AS POSSIBLE TO AVOID DETERIORATION TO THE **WOOD**.

OSTO DRESDEN 34

